

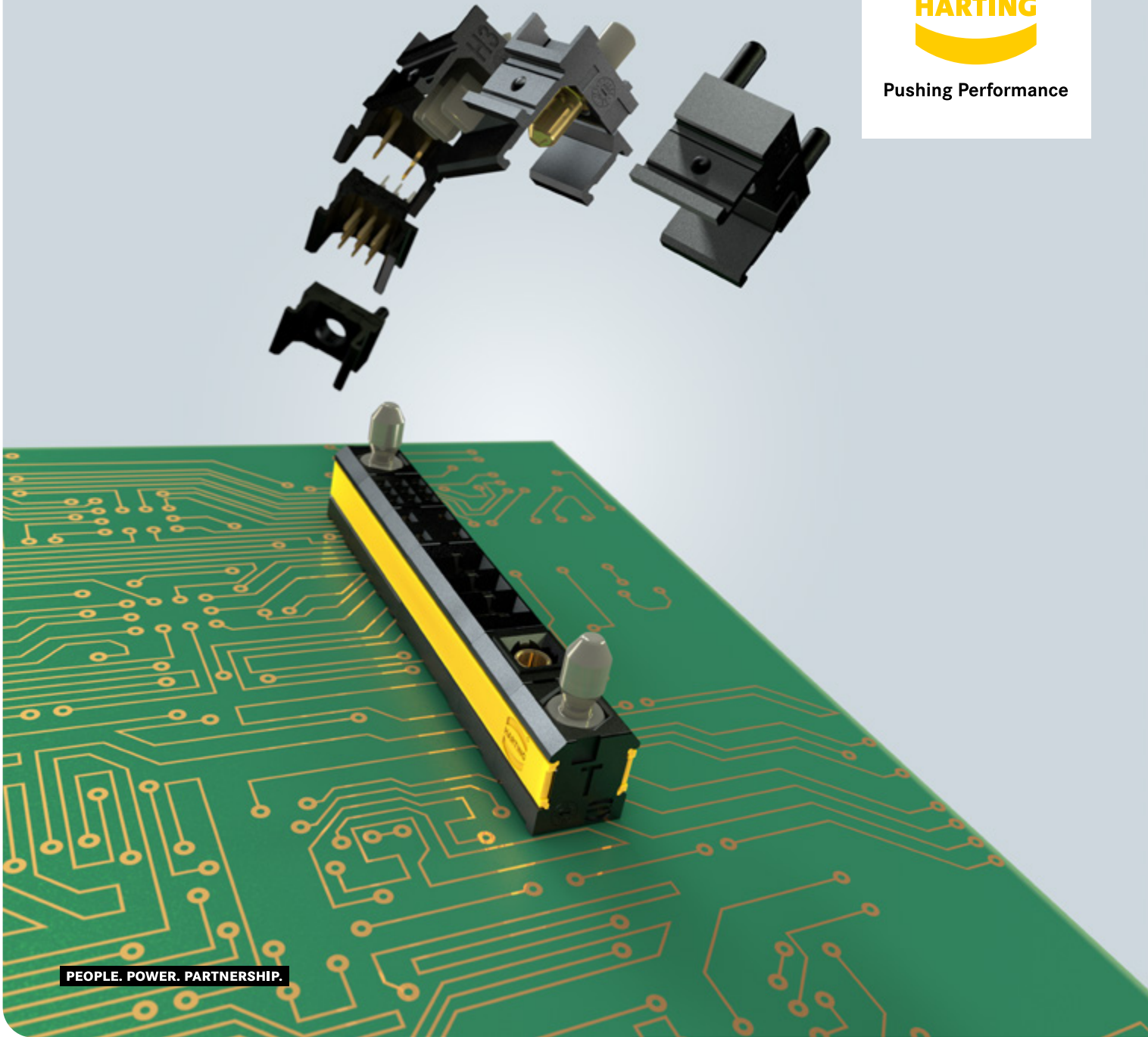

Pushing Performance



PEOPLE. POWER. PARTNERSHIP.

HARTING *har-modular*[®]

The modular solution for your Board-to-Board application.

har-modular[®]



**CREATE
YOUR
OWN**

Transforming customer wishes into concrete solutions



The HARTING Technology Group is skilled in the fields of electrical, electronic and optical connection, transmission and networking technology, as well as in manufacturing, mechatronics and software creation. The Group uses these skills to develop customized solutions and products such as connectors for energy and data-transmission /data-networking applications, including, for example, mechanical engineering, rail technology, wind energy plants, factory automation and the telecommunications sector. In addition, HARTING also produces electro-magnetic components for the automobile industry and offers solutions in the field of housing technology and shop systems.

The HARTING Group currently comprises 58 sales companies and production plants worldwide employing a total of about 5,500 staff.

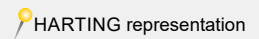
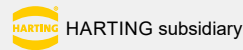

We aspire to top performance.

Connectors ensure functionality. As core elements of electrical and optical termination, connection and infrastructure technologies, they are essential in enabling the modular construction of devices, machines and systems across an extremely wide range of industrial applications. Their reliability is a crucial factor guaranteeing smooth functioning in the manufacturing area, telecommunications, applications in medical technology – in short, connectors are at work in virtually every conceivable application area. Thanks to the ongoing development of our technologies, our customers enjoy investment security and benefit from durable, long-term functionality.

Wherever our customers are, we're there.

Increasing industrialization is creating growing markets that are characterized by widely diverging demands and requirements. What these markets all share in common is the quest for perfection, increasingly efficient processes and reliable technologies. HARTING is providing these technologies – in Europe, the Americas and Asia. In order to implement customer requirements in the best possible manner, the HARTING professionals at our international subsidiaries engage in up-close, partnership-based interaction with our customers, right from the very early product development phase.

Our on-site staff form the interface to the centrally coordinated development and production departments. In this way, our customers can rely on consistently high, superior product quality – worldwide.

Our claim: Pushing Performance.

HARTING provides more than optimally attuned components. In order to offer our customers the best possible solutions, on request HARTING contributes a great deal more and is tightly integrated into the value-creation process. From ready-assembled cables through to control racks or ready-to-go control desks. Our aim is to generate maximum benefit for our customers – with no compromises!

Quality creates reliability – and warrants trust.

The HARTING brand stands for superior quality and reliability – worldwide. The standards we set are the result of consistent, stringent quality management that is subject to regular certifications and audits. EN ISO 9001, the EU Eco-Audit and ISO 14001:2004 are key elements here. We take a proactive stance towards new requirements, which is why HARTING is the first company worldwide to have obtained the new IRIS quality certificate for rail vehicles.



HARTING technology creates added value for customers.

Technologies by HARTING are at work worldwide.

HARTING's presence stands for smoothly functioning systems powered by intelligent connectors, smart infrastructure solutions and sophisticated network systems. Over the course of many years of close, trust-based cooperation with its customers, the HARTING Technology Group has become one of the leading specialists globally for connector technology. We offer individual customers specific and innovative solutions that go beyond the basic standard functionalities. These tailored solutions deliver sustained results, ensure investment security and enable customers to achieve significant added value.

Opting for HARTING opens up an innovative, complex world of concepts and ideas.

In order to develop and produce connectivity and network solutions serving an exceptionally wide range of connector applications in a professional and cost-effective manner, HARTING not only commands the full array of conventional tools and basic technologies. Above and beyond these capabilities, HARTING is constantly harnessing and refining its broad base of knowledge and experience to create new solutions that also ensure continuity. To secure its lead in know-how, HARTING draws on a wealth of sources from its in-house research and applications.

Salient examples of these sources of innovative knowledge include micro structure technologies, 3D design and connection technology, high-temperature and ultra-high-frequency

applications that are finding use in telecommunications and automation networks, in the automotive industry, or in industrial sensor and actuator applications, RFID and wireless technologies, in addition to packaging and housing made of plastics, aluminium and stainless steel.

HARTING overcomes technological limitations.

Drawing on the comprehensive resources of the group's technology pool, HARTING devises practical solutions for its customers. Whether this involves industrial networks for manufacturing automation, or hybrid interface solutions for wireless telecommunication infrastructures, 3D circuit carriers with micro structures, or cable assemblies for high-temperature applications in the automotive industry – HARTING technologies offer not only components, but comprehensive solutions attuned to individual customer requirements and preferences. The range of cost-effective solutions covers ready-to-use cable configurations, completely assembled backplanes and board system carriers, as well as fully wired and tested control panels. In order to ensure the future-proof design of RF and EMC-compatible interface solutions, the central HARTING laboratory (certified to EN 45001) employs simulation tools, as well as experimental, testing and diagnostics facilities all the way to scanning electron microscopes. In addition to product and process suitability considerations, life cycle and environmental aspects play a key role in the selection of materials and processes.

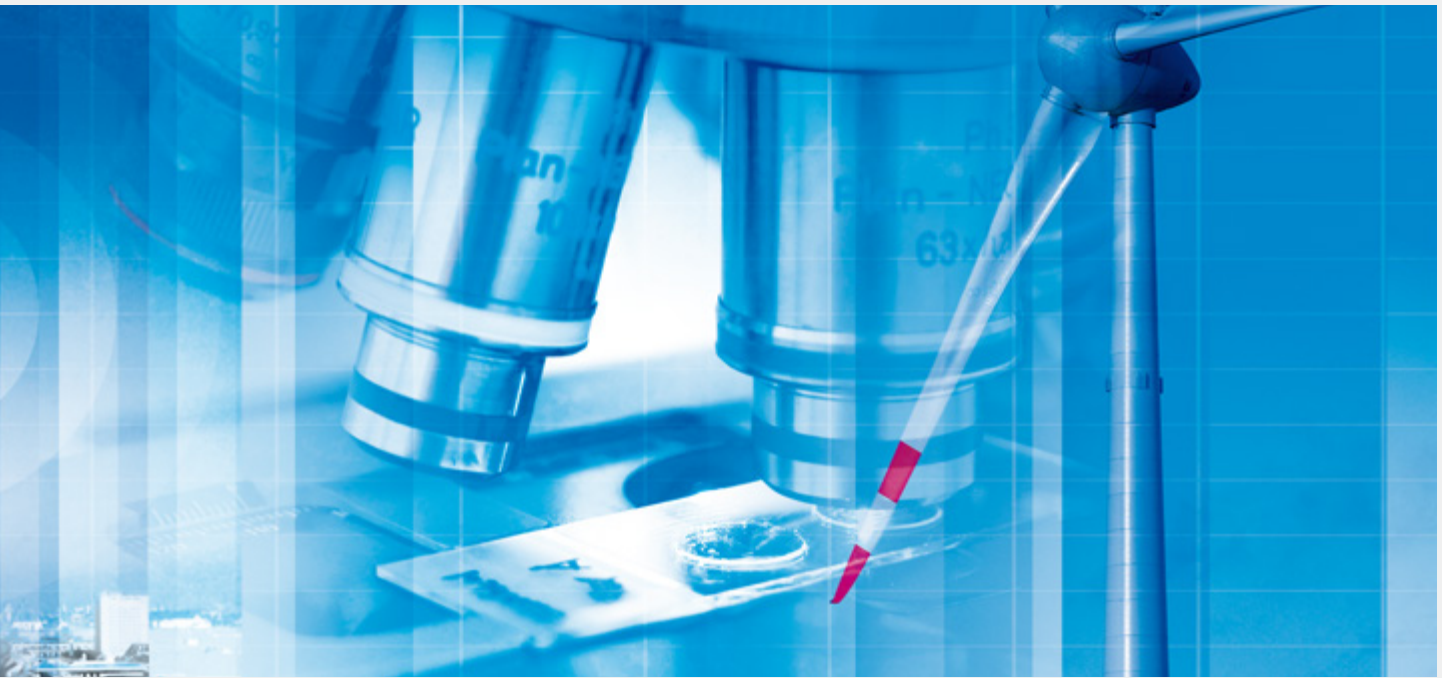

HARTING's knowledge is practical know-how that generates synergy effects.

HARTING commands decades of experience with regard to the applications conditions involved in connections in telecommunications, computer, network and medical technologies, as well as industrial automation technologies, e.g. in the mechanical engineering and plant engineering areas, in addition to the power generation industry and the transportation sector. HARTING is highly conversant with the

specific application areas in all of these technology fields. In every solution approach, the key focus is on the application. In this context, uncompromising, superior quality is our hallmark. Every new solution found invariably flows back into the HARTING technology pool, thereby enriching our resources. And every new solution we go on to create will draw on this wealth of resources in order to optimize each and every individual solution. HARTING is synergy in action.

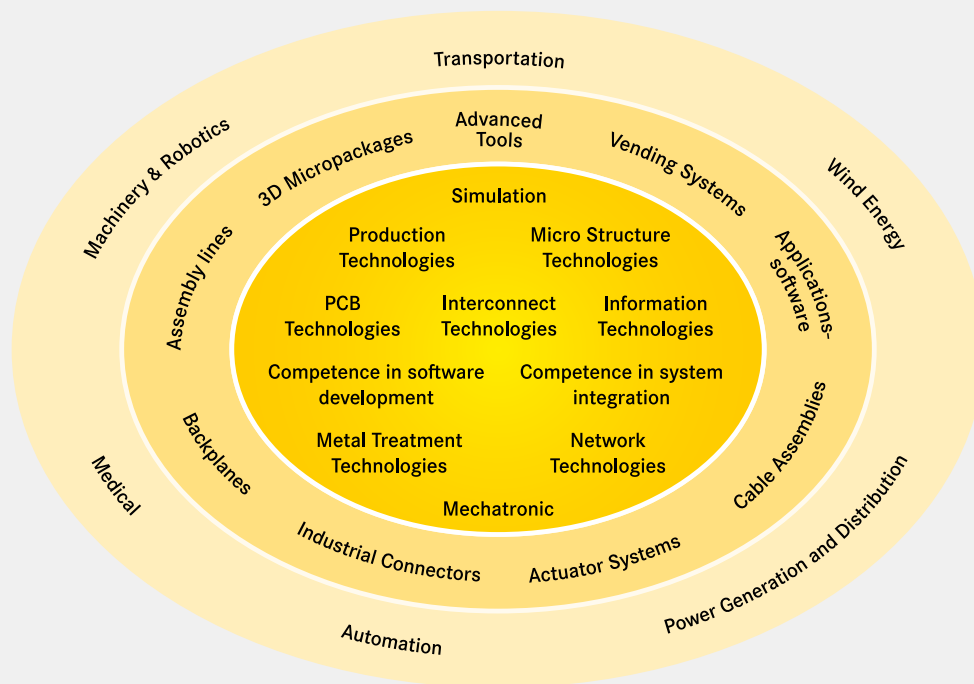



The **HARTING eCatalogue / eShop** can be found on our homepage at www.HARTING.com or at the direct link b2b.HARTING.com/ebusiness.

The **HARTING e-Catalogue** is your platform for conveniently selecting individual products as well as configuring complete solutions. Our comprehensive product pages provide you with all necessary technical information and CAD files in various formats for downloading. You may also contact our technical sales department directly.

Find out about product innovations and news on the start page of the HARTING e-Catalogue or go directly to www.harting.com/DE/en-gb/node/212.

Registered users can take advantage of MyHARTING to check on availability or prices, and to place or track their orders. Here, your customized "HARTING history" provides you with a list of your inquiries, quotations and more.

Sign up now for your free MyHARTING account at www.HARTING.com/service-account-registration!

Product samples: Fast-track delivery to your desk, free of charge

The new free express sample service in the HARTING eCatalogue allows customers to order samples immediately, easily and completely free of charge. A broad selection is now available. If a product is unavailable, the system offers alternative products with similar features that can be requested at a mouse click.

The free samples are shipped within 24 hours at no cost to you. This service enables tremendous flexibility, especially in the design phase of projects.

General information

It is the customer's responsibility to check whether the components illustrated in this catalogue also comply with different regulations from those stated in special fields of applications.

We reserve the right to modify designs or substance of content in order to improve quality, keep pace with technological advancement or meet particular requirements in production.

No part of this catalogue may be reproduced in any form (print, photocopy, microfilm or any other process) or processed, duplicated or distributed by means of electronic systems without the prior written consent of HARTING Technology Group, Espelkamp. We are bound by the German version only.

Contents	Page
General information	D10 01.2
C9 module	D10 01.4
F4 module.....	D10 01.6
H3 module	D10 01.8
M1 power module	D10 01.10
M1 coax module	D10 01.17
M1 high-voltage module	D10 01.24
M1 FO module.....	D10 01.27
P module	D10 01.31
T module.....	D10 01.33
Fixing rails	D10 01.35

New products for modular PCB connectors.

har-modular

HARTING *har-modular*[®]
The new modular solution for your Board-to-Board application.

CREATE YOUR OWN!

Developers know this. A good idea for a new product fails because of the availability of suitable components. Several lifelines of data, power and signals are to be routed from one PCB to another and no supplier has a suitable connector ready on the shelf. A special solution can be developed, but it usually takes too long and the minimum order quantity is too large for worthwhile prototyping. So in the end it becomes a stopgap solution from the best fitting connector available. So why not simply invent a connector that developers can assemble as they need it? Exactly. We call it *har-modular*[®]. A connector that is perfectly tailored to the individual application and can be configured online from numerous modules, offering an almost infinite number of individual solutions. From batch size 1, developers can always find the right connection using the modular principle.

Any arrangement, no matter how innovative and creative, within a device design is no longer dependent on whether there is a suitable standard strip or variant. The developer adapts the connector to his requirements. Not the other way round.



3 steps to your individual connector

With the *har-modular*[®] online configurator, you can now find your individual solution even more easily and quickly. Every conceivable combination can be configured here in three simple steps.

STEP 1 - Which modules and how many?

The *har-modular*[®] modular system offers modules for all three lifelines: power, signals and data. In the first step, you select the appropriate modules and their required number for your application.

The modules in detail:

Signal Modules

Two modules are available for the transmission of signals:

- 9 contacts with a maximum current of 2A / contact
- 1 coax contact with 50 Ohm or 75 Ohm

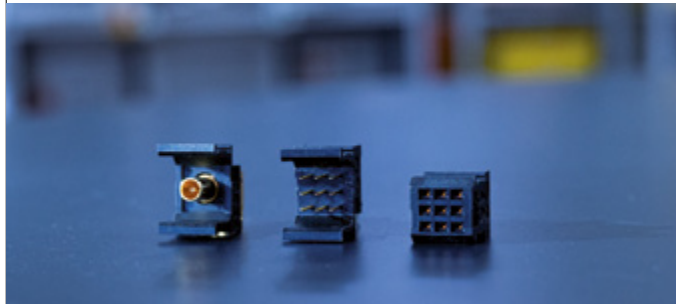

Power modules

Three modules are available for the transmission of power:

- 1 contact with a maximum current of 40 A / contact
- 3 contacts with a maximum current of 15 A / contact
- 4 contacts with a maximum current of 6 A / contact

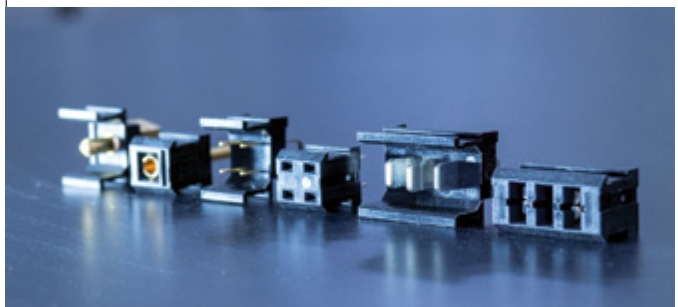

High-voltage modules

A module is available for the transmission of high voltage:

- 1 contact at a maximum of 2,800 V at 1.5 A

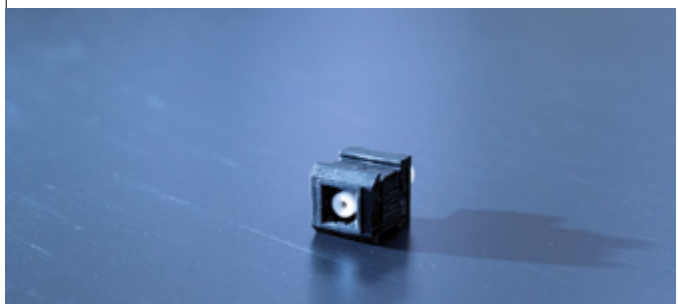

New products for modular PCB connectors.

har-modular

STEP 2 - The guiding pin

For the secure connection of all modules, each *har-modular*[®] connector requires two guide pins. Depending on your application, you can choose guide pins in plastic or metal. If you ask us, the best position for the guide pins is always the end of the connector. But any other position is also possible.

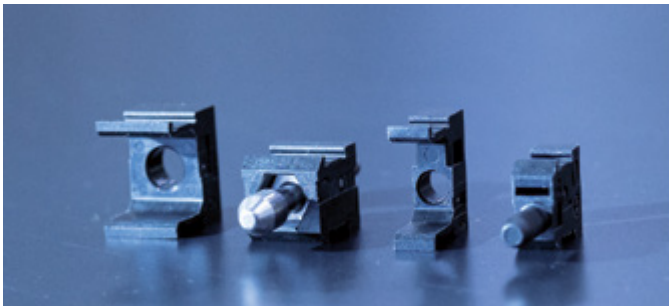

STEP 3 - The connecting rail

Select the appropriate yellow fastening rail for this step. It must have the same length as all the modules together. In the next step, take the mounting tool and put your modules side by side on the module. Depending on your modules, use the MALE or FEMALE side up. Now press the top edge of the mounting strip into the top slot of the module. Start this at one of the two ends and connect one module at a time. Do the same on the opposite side.

DONE!



All modules can be freely combined in widths from 20 to 172 millimetres. The principle always remains the same. Select modules, select guide pins, insert connecting rails and the connector is ready. The position of the elements among each other is completely free and can be recombined again and again. In just a few steps, an absolutely customised connection solution is created for rack systems and PCB applications of all kinds.

Who needs a modular connector?

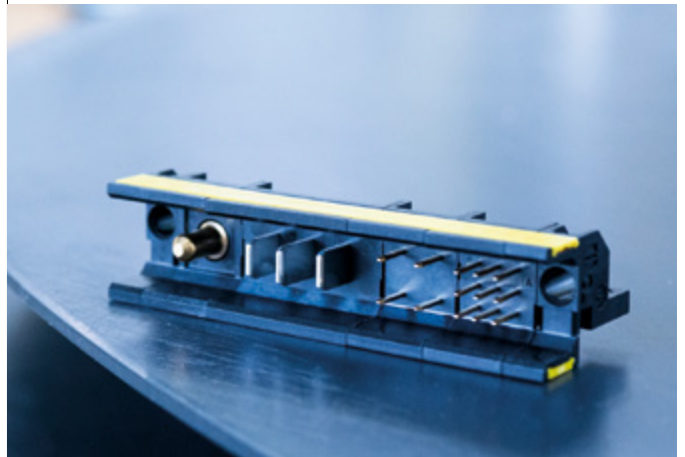

First and foremost, those users who cannot find the right solution for their application from the wide range of DIN 41612 connectors. Here, too, special solutions are possible, but not as quickly, and with *har-modular*[®] it is possible to respond even more specifically to every customer request. This also makes *har-modular*[®] the perfect solution for prototyping and small series. Here, the interface can be reconfigured quickly and developers are much freer in their design.

Good to know:

Of course, the *har-modular*[®] is suitable for pick&place, can be soldered on wave soldering systems as well as in the reflow process and arrives fully assembled at your premises from an order quantity of 200 pieces.

Technical characteristics

Contact spacing (mating side)	2.54 mm
Rated current	2 A
Test voltage $U_{r.m.s.}$	1 kV
Insulation resistance	$>10^{11} \Omega$
Contact resistance	$\leq 20 \text{ m}\Omega$
Limiting temperature	-55 ... +125 °C (during reflow soldering max. +240 °C for 15 s)
Mating cycles	≥ 500
Clearance distance	1 mm in the module 1.9 mm to module edge
Creepage distance	1 mm in the module 1.8 mm to module edge
Termination length	3 mm, 4.8 mm, 4.5 mm
Railway classification	F1/I2, acc. to NFF 16-101/102
Performance level	1
Mating cycles	≥ 500
Material (insert)	Polyamide (PA)
Isolation group	I, (600 \leq CTI)
Colour (insert)	Black
Material (contacts)	Copper alloy
Surface (contacts)	Noble metal over Ni, Mating side Sn over Ni, Termination side
Material flammability class acc. to UL 94	V-0
RoHS	compliant

Specifications and approvals

UL 1977 ECBT2.E102079
CSA-C22.2 No. 182.3 ECBT8.E102079

Details

Board drillings

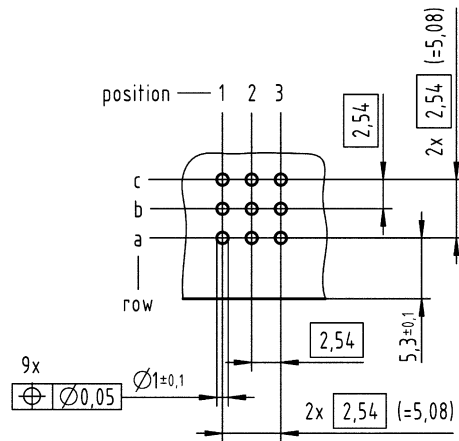





Width of the module

10.16 mm

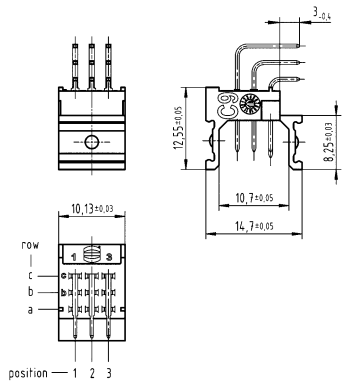

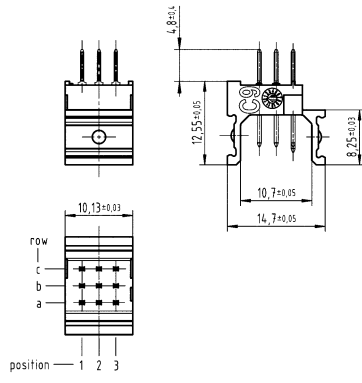
har-modular

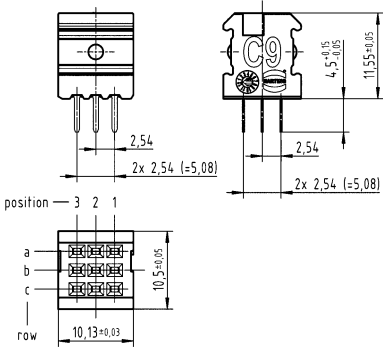
Identification	Number of contacts	Leading contact	Part number	Drawing (dimensions in mm)
<p>har-modular®, C9 module, Male connector, Reflow soldering termination (THR), Wave soldering termination, Angled</p> 	<p>9 9 9</p>	<p>a1 a3</p>	<p>02 51 909 1101 02 51 909 1102 02 51 909 1103</p>	
<p>har-modular®, C9 module, Male connector, Reflow soldering termination (THR), Wave soldering termination, Straight</p> 	<p>9 9 9</p>	<p>a1 a3</p>	<p>02 53 909 1101 02 53 909 1102 02 53 909 1103</p>	
<p>har-modular®, C9 module, Female connector, Reflow soldering termination (THR), Wave soldering termination, Straight</p> 	<p>9</p>		<p>02 52 909 1101</p>	

Technical characteristics

Contact spacing (mating side)	5.08 mm
Rated current	6 A
Test voltage $U_{r.m.s.}$	1.55 kV
Insulation resistance	$>10^{11} \Omega$
Contact resistance	$\leq 15 \text{ m}\Omega$
Limiting temperature	-55 ... +125 °C (during reflow soldering max. +240 °C for 15 s)
Mating cycles	≥ 500
Clearance distance	3 mm in the module 1.6 mm to module edge
Creepage distance	3 mm in the module 1.6 mm to module edge
Termination length	3 mm, 4.8 mm, 4.5 mm
Railway classification	F1/I2, acc. to NFF 16-101/102
Performance level	1
Mating cycles	≥ 500
Material (insert)	Polyamide (PA)
Isolation group	I, (600 \leq CTI)
Colour (insert)	Black
Material (contacts)	Copper alloy
Surface (contacts)	Noble metal over Ni, Mating side Sn over Ni, Termination side
Material flammability class acc. to UL 94	V-0
RoHS	compliant

Specifications and approvals

UL 1977 ECBT2.E102079
CSA-C22.2 No. 182.3 ECBT8.E102079

Details

Board drillings

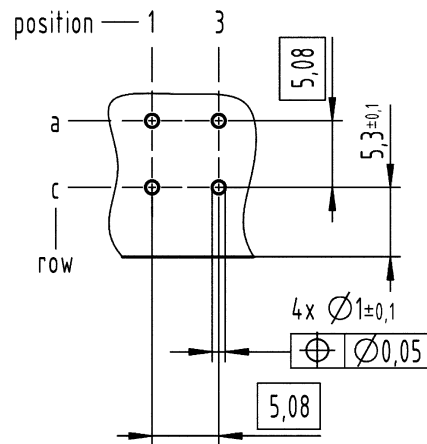





Width of the module

10.16 mm

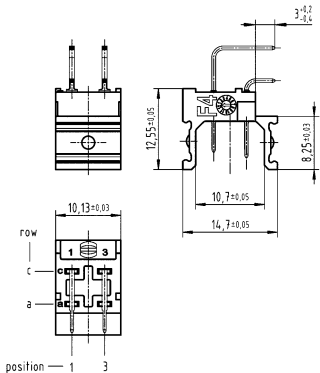

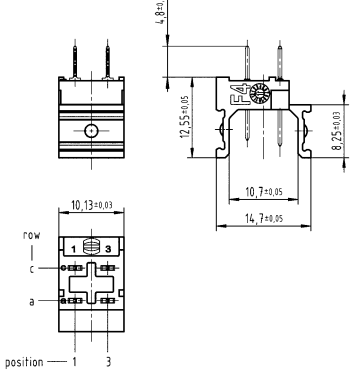
har-modular

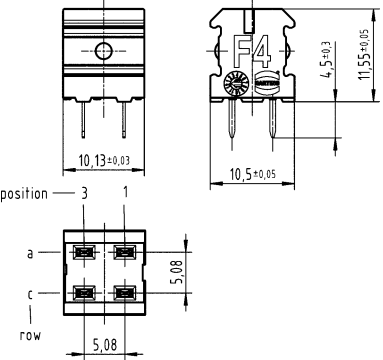
Identification	Number of contacts	Leading contact	Part number	Drawing (dimensions in mm)
<p>har-modular®, F4 module, Male connector, Rows a and c, positions 1 and 3, Reflow soldering termination (THR), Wave soldering termination, Angled</p> 	4 4	a1	02 51 904 1201 02 51 904 1202	
<p>har-modular®, F4 module, Male connector, Rows a and c, positions 1 and 3, Reflow soldering termination (THR), Wave soldering termination, Straight</p> 	4 4	a1	02 53 904 1201 02 53 904 1202	
<p>har-modular®, F4 module, Female connector, Rows a and c, positions 1 and 3, Reflow soldering termination (THR), Wave soldering termination, Straight</p> 	4		02 52 904 1201	

Technical characteristics

Contact spacing (mating side)	5.08 mm
Rated current	15 A
Test voltage $U_{r.m.s.}$	2.5 kV
Insulation resistance	$>10^{11} \Omega$
Contact resistance	$\leq 8 \text{ m}\Omega$
Limiting temperature	-55 ... +125 °C (during reflow soldering max. +240 °C for 15 s)
Mating cycles	≥ 500
Clearance distance	4 mm in the module 4.4 mm to module edge
Creepage distance	4.4 mm in the module 4.6 mm to module edge
Termination length	2.8 mm, 4.8 mm, 4.1 mm
Railway classification	F1/I2, acc. to NFF 16-101/102
Performance level	1
	acc. to IEC 60603-2
Mating cycles	≥ 500
Material (insert)	Polyamide (PA)
Isolation group	I, ($600 \leq \text{CTI}$)
Colour (insert)	Black
Material (contacts)	Copper alloy
Surface (contacts)	Silver plated, Mating side Sn over Ni, Termination side
Material flammability class acc. to UL 94	V-0
RoHS	compliant

Specifications and approvals

UL 1977 ECBT2.E102079
CSA-C22.2 No. 182.3 ECBT8.E102079

Details

Board drillings

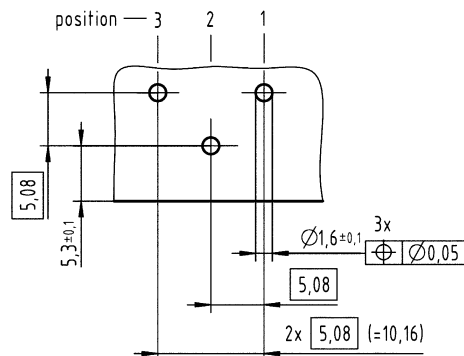

for angled male connectors

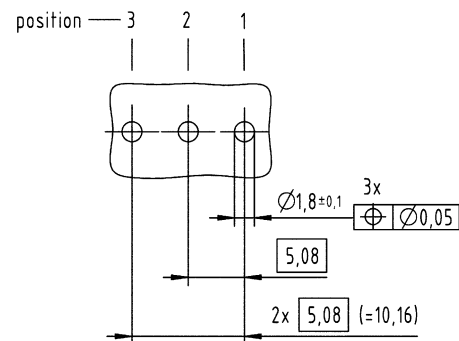



for straight male connectors

Width of the module

20.32 mm



har-modular

Identification	Number of contacts	Leading contact	Part number	Drawing (dimensions in mm)
<p>har-modular®, H3 module, Male connector, Reflow soldering termination (THR), Wave soldering termination, Angled</p> 	3	2	02 51 903 1301	
<p>har-modular®, H3 module, Male connector, Reflow soldering termination (THR), Wave soldering termination, Straight</p> 	3	2	02 53 903 1301	
<p>har-modular®, H3 module, Female connector, Reflow soldering termination (THR), Wave soldering termination, Straight</p> 	3		02 52 903 1301	

Technical characteristics

Test voltage $U_{r.m.s.}$	1.55 kV
Insulation resistance	$>10^{11} \Omega$
Limiting temperature	-55 ... +125 °C
Mating cycles	≥ 500
Conductor cross-section	1.5 mm ² 4 mm ² 10 mm ²
Clearance distance	4 mm in the module 2 mm to module edge
Creepage distance	4 mm in the module 2 mm to module edge
Railway classification	F1/I2, acc. to NFF 16-101/102
Performance level	1
Mating cycles	≥ 500
Material (insert)	Polyamide (PA)
Isolation group	I, ($600 \leq CTI$)
Colour (insert)	Black
Material (contacts)	Copper alloy
Surface (contacts)	Noble metal over Ni, Mating side Sn over Ni, Termination side
Material flammability class acc. to UL 94	V-0
RoHS	compliant compliant with exemption

Derating

Current carrying capacity

The current carrying capacity of the connectors is limited by the thermal load capability of the contact element material including the connections and the insulating parts. The derating curve is therefore valid for currents which flow constantly (non-intermittent) through each contact element of the connector evenly, without exceeding the allowed maximum temperature.

Measuring and testing techniques acc. to IEC 60512-5-2

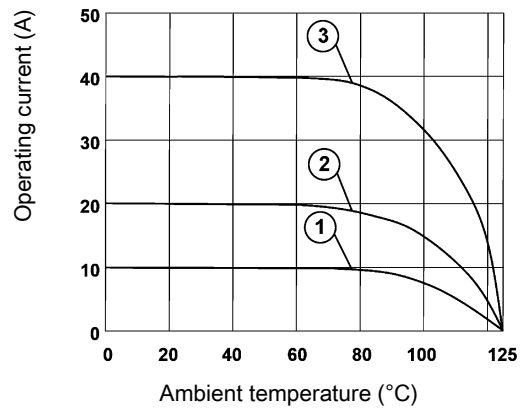

- ① 10 A
- ② 20 A
- ③ 40 A

Specifications and approvals

UL 1977 ECBT2.E102079
 CSA-C22.2 No. 182.3 ECBT8.E102079
 DIN 41626

M1 power module



har-
modular

Identification	Number of contacts	Conductor cross-section (mm ²)	Operating current	Part number	Drawing (dimensions in mm)
DIN 41612, Crimp contact, Male contact for male connectors	4 10	1.5	≤10 A ≤20 A ≤40 A	09 03 000 6113 09 03 000 6114 09 03 000 6115	
DIN 41612, Solder contact, Straight, Male contact for male connectors			≤10 A ≤20 A ≤40 A	09 03 000 6101 09 03 000 6102 09 03 000 6103	
DIN 41612, Solder contact, Straight, Leading contact, Male contact for male connectors			≤40 A	09 03 000 6133	

D10
01
·
12

M1 power module





Width of the module

10.16 mm

Male connectors Low construction type



har-modular

Identification	Number of contacts	Operating current	Part number	Drawing (dimensions in mm)
<p>har-modular®, M1 module, flat, Male connector, Straight</p>  <p>Please order contacts separately.</p>	<p>1</p>		<p>02 53 901 0451</p>	
<p>DIN 41612, PCB solder contact, Straight, Male contact for male connectors</p> 		<p>≤40 A</p>	<p>09 03 000 6136</p>	

M1 power module







Width of the module

10.16 mm

Male connectors



har-modular

Identification	Number of contacts	Conductor cross-section (mm ²)	Operating current	Part number	Drawing (dimensions in mm)
<p>har-modular®, M1 module, Male connector, Straight</p>  <p>Please order contacts separately.</p>	1			02 53 901 0401	
<p>DIN 41612, Crimp contact, Male contact for male connectors</p> 		1.5 4 10	≤10 A ≤20 A ≤40 A	09 03 000 6113 09 03 000 6114 09 03 000 6115	
<p>DIN 41612, Solder contact, Straight, Male contact for male connectors</p> 			≤10 A ≤20 A ≤40 A	09 03 000 6101 09 03 000 6102 09 03 000 6103	
<p>DIN 41612, Solder contact, Straight, Leading contact, Male contact for male connectors</p> 			≤40 A	09 03 000 6133	

D10
01
·
14



Width of the module

10.16 mm

Female connectors Low construction type

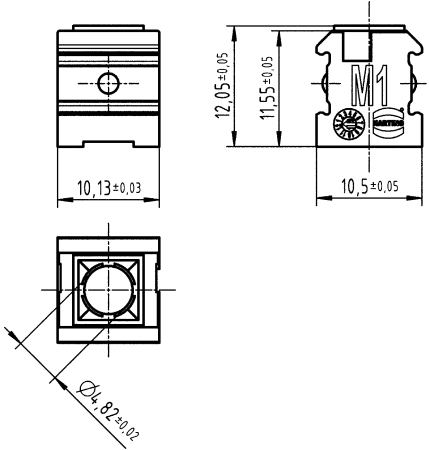

har-modular

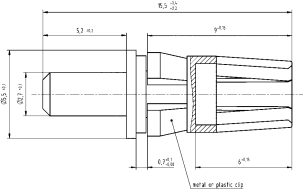
Identification	Number of contacts	Operating current	Part number	Drawing (dimensions in mm)
<p>har-modular®, M1 module, flat, Female connector, Straight</p>  <p>Please order contacts separately.</p>	<p>1</p>		<p>02 52 901 0451</p>	
<p>DIN 41612, PCB solder contact, Straight, Female contact for female connectors</p> 		<p>≤40 A</p>	<p>09 03 000 6225</p>	

M1 power module







Width of the module

10.16 mm

Female connectors

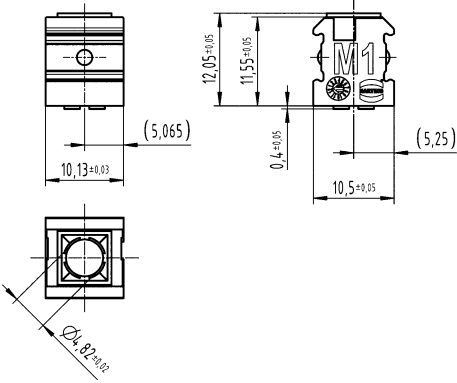

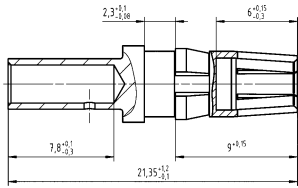
har-modular

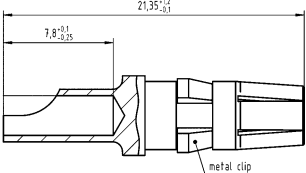
Identification	Number of contacts	Conductor cross-section (mm ²)	Operating current	Part number	Drawing (dimensions in mm)
<p>har-modular®, M1 module, Female connector, Straight</p>  <p>Please order contacts separately.</p>	1			02 52 901 0401	
<p>DIN 41612, Crimp contact, Straight, Female contact for female connectors</p> 		1.5 4 10	≤10 A ≤20 A ≤40 A	09 03 000 6213 09 03 000 6214 09 03 000 6215	
<p>DIN 41612, Solder contact, Straight, Female contact for female connectors</p> 			≤10 A ≤20 A ≤40 A	09 03 000 6201 09 03 000 6202 09 03 000 6203	

D10
01
·
16

Technical characteristics

Rated voltage	250 V
Test voltage $U_{r.m.s.}$	1.55 kV 0.75 kV
Insulation resistance	$>10^{11} \Omega$ $>10^9 \Omega$
Contact resistance	$\leq 10 \text{ m}\Omega$ for inner contact die $\leq 3 \text{ m}\Omega$ for outer ferrule
Impedance	50 Ω , 75 Ω
Limiting temperature	-55 ... +125 °C
Mating cycles	≥ 500
Clearance distance	4 mm in the module 2 mm to module edge
Creepage distance	4 mm in the module 2 mm to module edge
Frequency	4 GHz 2 GHz 1 GHz 10 GHz
Railway classification	F1/I2, acc. to NFF 16-101/102
Performance level	1

Technical characteristics

Mating cycles	≥ 500
Material (insert)	Polyamide (PA)
Isolation group	I, ($600 \leq \text{CTI}$)
Colour (insert)	Black
Material (locking)	Copper alloy Thermoplastic
Material (contacts)	Copper alloy
Surface (contacts)	Noble metal over Ni, Mating side
Material flammability class acc. to UL 94	V-0
RoHS	compliant compliant with exemption

har-modular

Specifications and approvals





UL 1977 ECBT2.E102079
CSA-C22.2 No. 182.3 ECBT8.E102079
DIN 41626

Width of the module

10.16 mm

Male connectors

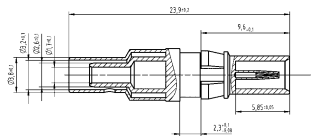

Identification	Number of contacts	Operating current	Impedance	Part number	Drawing (dimensions in mm)
<p><i>har-modular</i>[®], M1 module, Male connector, Angled</p>  <p>Please order contacts separately.</p>	1			02 51 901 0401	
<p>DIN 41612, Coaxial contact, PCB solder termina- tion, Angled, Female contact for male connectors</p> 		≤1.5 A ≤1.5 A	50 Ω 75 Ω	09 03 000 6262 09 03 000 6269	
<p>DIN 41612, Coaxial contact, Solder/crimp termina- tion, Straight, With knurled area, Female contact for male connectors</p> 		≤1.4 A	50 Ω	09 03 000 6274	
<p>DIN 41612, Coaxial contact, Solder/crimp termina- tion, Angled, Female contact for male connectors</p> 		≤1.4 A	50 Ω	09 03 000 6261	

Identification	Number of contacts	Operating current	Impedance	Part number	Drawing (dimensions in mm)
<p>DIN 41612, Coaxial contact, Solder/crimp termination, Straight, Female contact for male connectors</p> 		<p>≤0.4 A ≤1.4 A</p>	<p>75 Ω 50 Ω</p>	<p>09 14 000 6221 09 03 000 6260</p>	

har-
modular

M1 coax module







Width of the module

10.16 mm

Male connectors

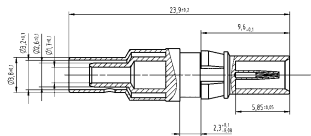

Identification	Number of contacts	Operating current	Impedance	Part number	Drawing (dimensions in mm)
<p><i>har-modular</i>[®], M1 module, Male connector, Straight</p>  <p>Please order contacts separately.</p>	1			02 53 901 0401	
<p>DIN 41612, Coaxial contact, Solder/crimp termination, Straight, With knurled area, Female contact for male connectors</p> 		≤1.4 A	50 Ω	09 03 000 6274	
<p>DIN 41612, Coaxial contact, Solder/crimp termination, Angled, Female contact for male connectors</p> 		≤1.4 A	50 Ω	09 03 000 6261	

Identification	Number of contacts	Operating current	Impedance	Part number	Drawing (dimensions in mm)
<p>DIN 41612, Coaxial contact, Solder/crimp termination, Straight, Female contact for male connectors</p> 		<p>≤0.4 A ≤1.4 A</p>	<p>75 Ω 50 Ω</p>	<p>09 14 000 6221 09 03 000 6260</p>	

har-
modular

M1 coax module





Width of the module

10.16 mm

Female connectors Low construction type

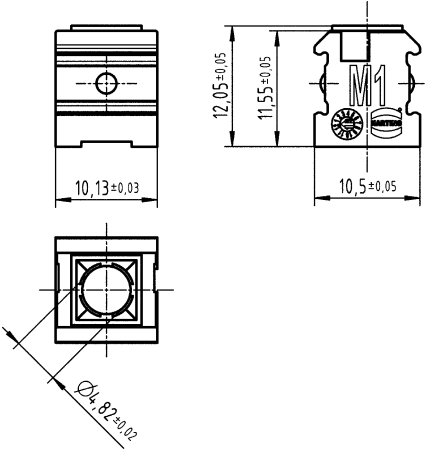

har-modular

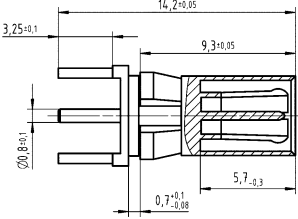
Identification	Number of contacts	Operating current	Impedance	Part number	Drawing (dimensions in mm)
<p>har-modular®, M1 module, flat, Female connector, Straight</p> 	<p>1</p>			<p>02 52 901 0451</p>	
<p>Please order contacts separately.</p>					
<p>DIN 41612, Coaxial contact, PCB solder termination, Straight, Male contact for female connectors</p> 		<p>≤1.5 A</p>	<p>50 Ω</p>	<p>09 03 000 6182</p>	

D10
01
·
22





Width of the module

10.16 mm

Female connectors

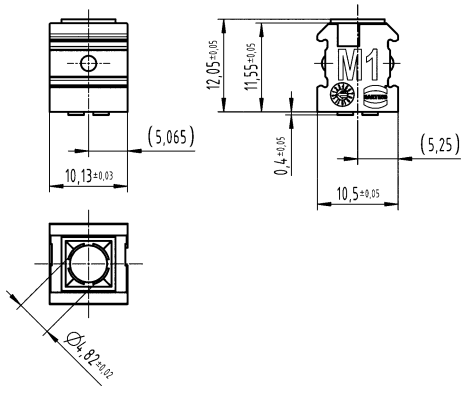

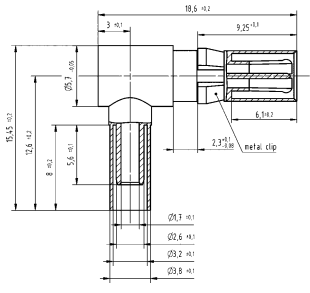
har-modular

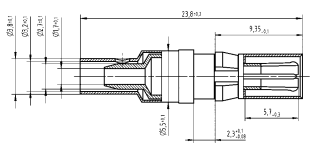
Identification	Number of contacts	Operating current	Impedance	Part number	Drawing (dimensions in mm)
<p>har-modular®, M1 module, Female connector, Straight</p>  <p>Please order contacts separately.</p>	1			02 52 901 0401	
<p>DIN 41612, Coaxial contact, Solder/crimp termination, Angled, Male contact for female connectors</p> 		≤1.4 A	50 Ω	09 03 000 6161	
<p>DIN 41612, Coaxial contact, Solder/crimp termination, Straight, Male contact for female connectors</p> 		≤0.4 A ≤1.4 A	75 Ω 50 Ω	09 03 000 6181 09 03 000 6160	

Technical characteristics

Rated voltage	2800 V
Test voltage $U_{r.m.s.}$	1.55 kV
Insulation resistance	$>10^{11} \Omega$
Limiting temperature	-55 ... +125 °C
Mating cycles	≥ 500
Clearance distance	4 mm in the module 2 mm to module edge
Creepage distance	4 mm in the module 2 mm to module edge
Railway classification	F1/I2, acc. to NFF 16-101/102
Performance level	1
Mating cycles	≥ 500
Material (insert)	Polyamide (PA)
Isolation group	I, ($600 \leq CTI$)
Colour (insert)	Black

Technical characteristics

Material (contacts)	Copper alloy
Surface (contacts)	Noble metal over Ni, Mating side
Material flammability class acc. to UL 94	V-0
RoHS	compliant compliant with exemption

Specifications and approvals

UL 1977 ECBT2.E102079
 CSA-C22.2 No. 182.3 ECBT8.E102079
 DIN 41626

har-
modular

M1 high-voltage module







Width of the module

10.16 mm

Male connectors

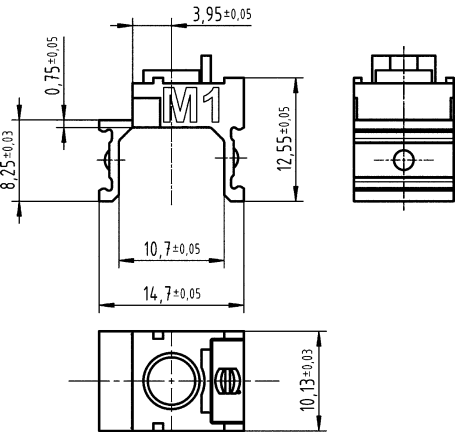

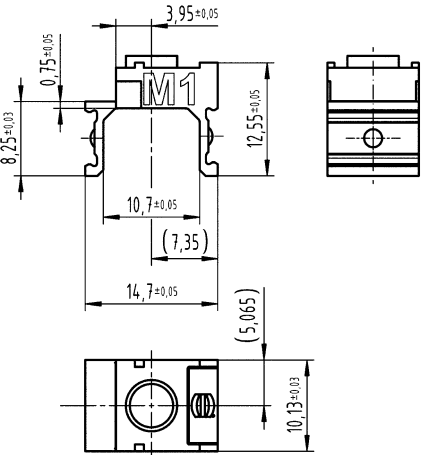
har-modular

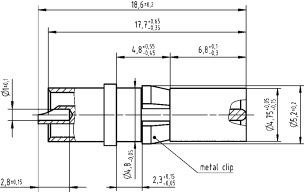

Identification	Number of contacts	Part number	Drawing (dimensions in mm)
<p>har-modular®, M1 module, Male connector, Angled</p>  <p>Please order contacts separately.</p>	1	02 51 901 0401	
<p>har-modular®, M1 module, Male connector, Straight</p>  <p>Please order contacts separately.</p>	1	02 53 901 0401	
<p>DIN 41612, Solder contact, Straight, Male contact for male connectors</p> 		09 03 000 6140	

Width of the module

10.16 mm

Female connectors

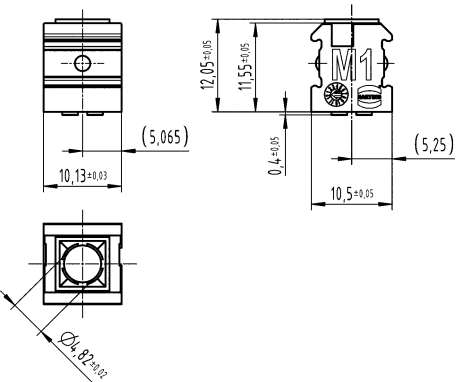

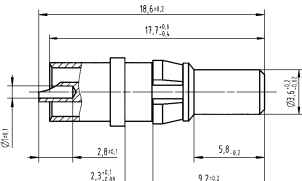
Identification	Number of contacts	Part number	Drawing (dimensions in mm)
<p>har-modular®, M1 module, Female connector, Straight</p>  <p>Please order contacts separately.</p>	1	02 52 901 0401	
<p>DIN 41612, Solder contact, Straight, Female contact for female connectors</p> 		09 03 000 6240	

Technical characteristics

Test voltage $U_{r.m.s.}$	1.55 kV
Insulation resistance	$>10^{11} \Omega$
Limiting temperature	-55 ... +125 °C
Mating cycles	≥ 500
Clearance distance	4 mm in the module 2 mm to module edge
Creepage distance	4 mm in the module 2 mm to module edge
Railway classification	F1/I2, acc. to NFF 16-101/102
Mating cycles	≥ 500
Material (insert)	Polyamide (PA)
Isolation group	I, ($600 \leq CTI$)

Technical characteristics

Colour (insert)	Black
Material flammability class acc. to UL 94	V-0
RoHS	compliant compliant with exemption

Specifications and approvals

UL 1977 ECBT2.E102079
CSA-C22.2 No. 182.3 ECBT8.E102079

M1 FO module







Width of the module

10.16 mm

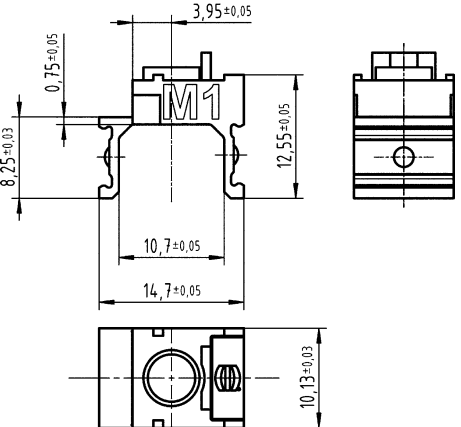
Male connectors

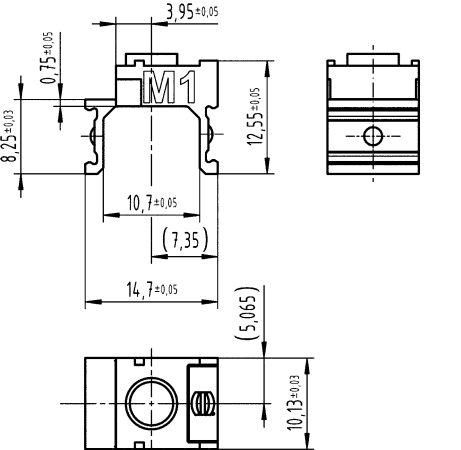

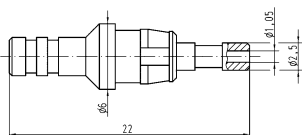
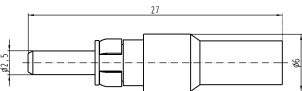
Identification	Num-ber of contacts	Part number	Drawing (dimensions in mm)
<p><i>har-modular</i>®, M1 module, Male connector, Angled</p>  <p>Please order contacts separately.</p>	1	02 51 901 0401	
<p><i>har-modular</i>®, M1 module, Male connector, Straight</p>  <p>Please order contacts separately.</p>	1	02 53 901 0401	
<p>DIN 41612, FO contact, for 1 mm plastic fibre, Male contact for male connectors</p> 		20 10 001 4211	
<p>DIN 41612, FO contact, for GI fibre 50/125 µm, for ceramic ferrule 62.5/125 µm, Male contact for male connectors</p>		20 10 125 4212	

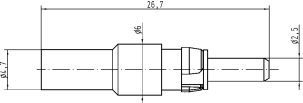
Identification	Num- ber of contacts	Part number	Drawing (dimensions in mm)
DIN 41612, FO contact, for SI fibre (HCS®) 200/230 µm, Male contact for male connectors		20 10 230 4211	





har-
modular

Width of the module

10.16 mm

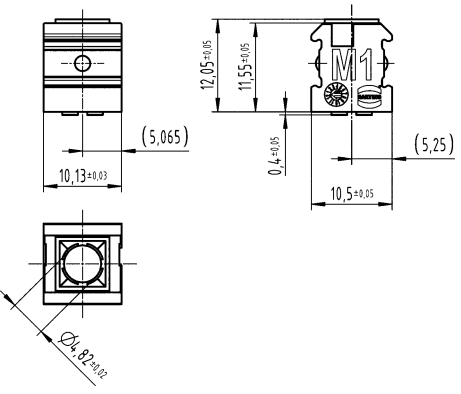
Female connectors

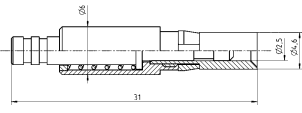

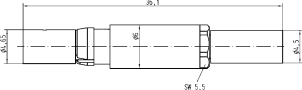
Identification	Num-ber of contacts	Part number	Drawing (dimensions in mm)
<p>har-modular®, M1 module, Female connector, Straight</p>  <p>Please order contacts separately.</p>	1	02 52 901 0401	
<p>DIN 41612, FO contact, for 1 mm plastic fibre, Female contact for female connectors</p> 		20 10 001 4221	
<p>DIN 41612, FO contact, for GI fibre 50/125 µm, for ceramic ferrule 62.5/125 µm, Female contact for female connectors</p>		20 10 125 4222	
<p>DIN 41612, FO contact, for SI fibre (HCS®) 200/230 µm, Female contact for female connectors</p>		20 10 230 4221	

Width of the module

5.08 mm



har-modular

Technical characteristics



Insulation resistance	$>10^{11} \Omega$
Limiting temperature	-55 ... +125 °C
Mating cycles	≥ 500
Railway classification	F1/I2, acc. to NFF 16-101/102
Mating cycles	≥ 500
Material (insert)	Polyamide (PA)
Isolation group	I, (600 \leq CTI)
Colour (insert)	Black
Colour (accessories)	Metallic

Technical characteristics

Material flammability class acc. to UL 94 V-0
RoHS compliant

Specifications and approvals

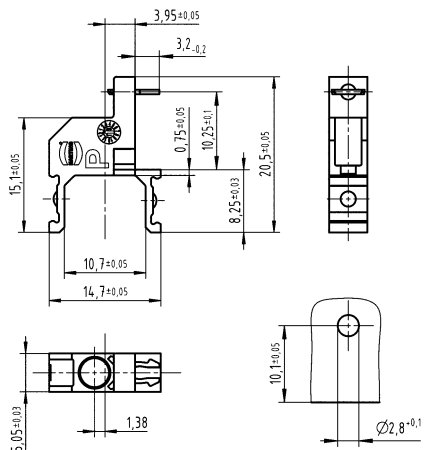
UL 1977 ECBT2.E102079
CSA-C22.2 No. 182.3 ECBT8.E102079

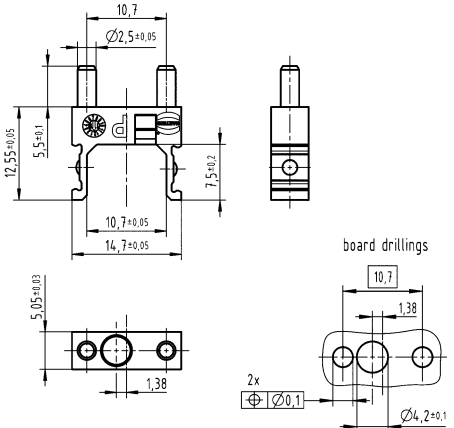
Identification		Part number	Drawing (dimensions in mm)
<p>har-modular®, P module, P spacer, Male connector, Angled</p> 	With board locks	02 51 900 0002 02 51 900 0004	
<p>har-modular®, P module, P spacer, Male connector, Straight</p> 	With fixing pin With guiding	02 53 900 0002 02 53 900 0005 02 53 900 0006	

har-modular

Identification

Part number

Drawing
(dimensions in mm)

har-modular®,
P module,
Female connector,
Straight



With board locks

02 52 900 0001
02 52 900 0002

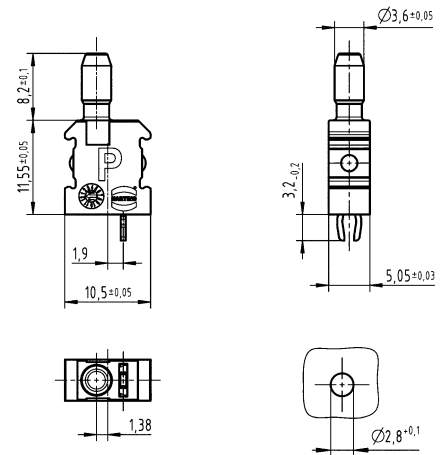

har-modular®,
P spacer,
Female connector,
Straight,
Empty module



With board locks

02 52 900 0004
02 52 900 0005

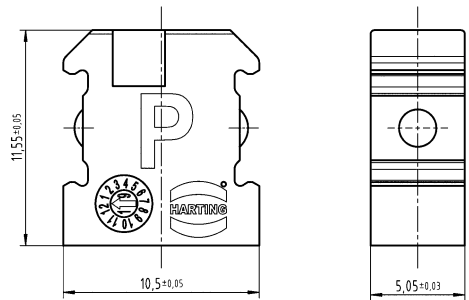

Pluggable with male connector

DIN 41612,
Screw,
M2.2 x 8,
for shell housing D 20/2,
for shell housing D 20/4,
for shell housing 2C, 3C,
har-modular® P module,
har-modular® T module - male connector



09 06 001 9979

Width of the module

10.16 mm



har-modular

Technical characteristics

Insulation resistance	$>10^{11} \Omega$
Limiting temperature	-55 ... +125 °C
Mating cycles	≥ 500
Railway classification	F1/I2, acc. to NFF 16-101/102
Mating cycles	≥ 500
Material (insert)	Polyamide (PA)
Isolation group	I, ($600 \leq CTI$)
Colour (insert)	Black
Colour (accessories)	Metallic
Material flammability class acc. to UL 94	V-0
RoHS	compliant

Details

Board drillings

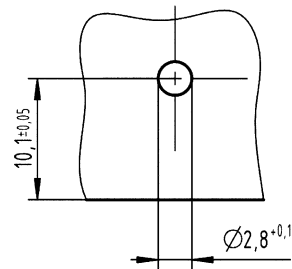

Specifications and approvals

UL 1977 ECBT2.E102079
CSA-C22.2 No. 182.3 ECBT8.E102079

Identification

har-modular®,
T module,
T spacer,
Male connector,
Angled



With board locks

Part number

02 51 900 0001
02 51 900 0003

Drawing (dimensions in mm)

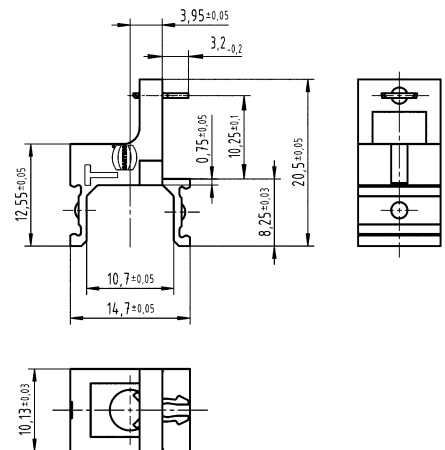

har-modular

Identification

har-modular®,
T module,
T spacer,
Male connector,
Straight



With fixing pin
With guiding

Part number

02 53 900 0001
02 53 900 0003
02 53 900 0004

Drawing
(dimensions in mm)

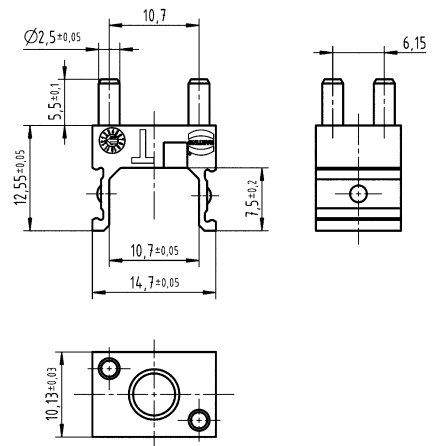

har-modular®,
T module,
T spacer,
Female connector,
Straight



02 52 900 0003

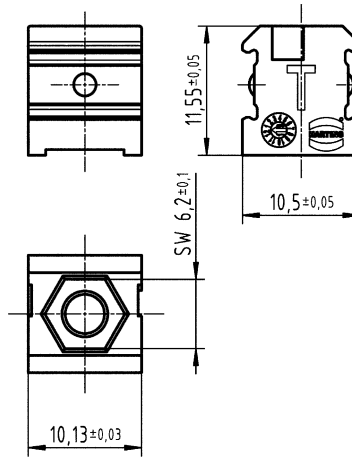

DIN 41612,
Screw,
M2.2 x 8,
for shell housing D 20/2,
for shell housing D 20/4,
for shell housing 2C, 3C,
har-modular® P module,
har-modular® T module - male connector



09 06 001 9979

har-modular®,
T module,
Coding pin,
for female connectors,
with selflocking nut



02 09 500 0004

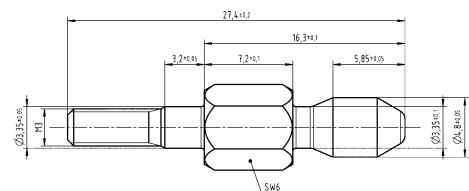



Technical characteristics

Isolation group	I, (600 ≤ CTI)
Colour (accessories)	Yellow
RoHS	compliant

Specifications and approvals

UL 1977 ECBT2.E102079
CSA-C22.2 No. 182.3 ECBT8.E102079

Details

The fixing rail must be 0.1 mm shorter than the module widths added together.

Identification	Length (L)	Part number	Drawing (dimensions in mm)
<i>har-modular</i> [®] , Fixing rail	20.22 mm	02 09 500 1004	
	25.3 mm	02 09 500 1005	
	30.38 mm	02 09 500 1006	
	35.46 mm	02 09 500 1007	
	40.54 mm	02 09 500 1008	
	45.62 mm	02 09 500 1009	
	50.7 mm	02 09 500 1010	
	55.78 mm	02 09 500 1011	
	60.86 mm	02 09 500 1012	
	65.94 mm	02 09 500 1013	
	71.02 mm	02 09 500 1014	
	76.1 mm	02 09 500 1015	
	81.18 mm	02 09 500 1016	
	86.26 mm	02 09 500 1017	
	91.34 mm	02 09 500 1018	
	96.42 mm	02 09 500 1019	
	101.5 mm	02 09 500 1020	
	106.58 mm	02 09 500 1021	
	111.66 mm	02 09 500 1022	
	116.74 mm	02 09 500 1023	
	121.82 mm	02 09 500 1024	
	126.9 mm	02 09 500 1025	
	131.98 mm	02 09 500 1026	
	137.06 mm	02 09 500 1027	
	142.14 mm	02 09 500 1028	
	147.22 mm	02 09 500 1029	
	152.3 mm	02 09 500 1030	
	157.38 mm	02 09 500 1031	
	162.46 mm	02 09 500 1032	
	167.54 mm	02 09 500 1033	
	172.62 mm	02 09 500 1034	



Pushing Performance

HARTING.com
the gateway to your local website.
